

Directional control valves afford possibilities for controlling start, stop and direction of flow of a pressure fluid and thus accordingly start, stop and direction of movement of a user (cylinder or hydraulic motor).

The directional valves may be mounted in hydraulic systems in any desired position together with a subplate.

Sealing of mating faces is made by using O-rings which are included with the valve.



DESCRIPTION OF OPERATION

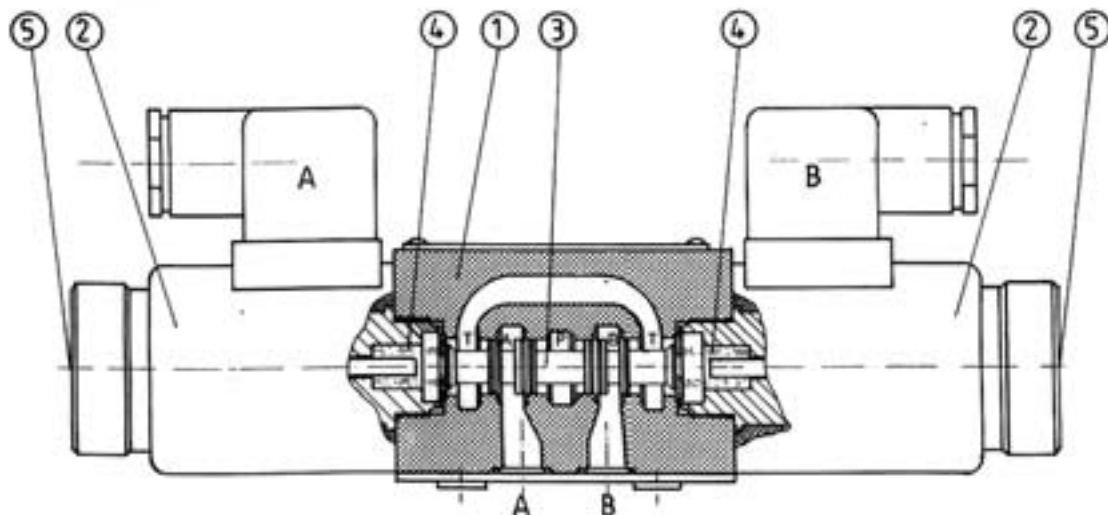
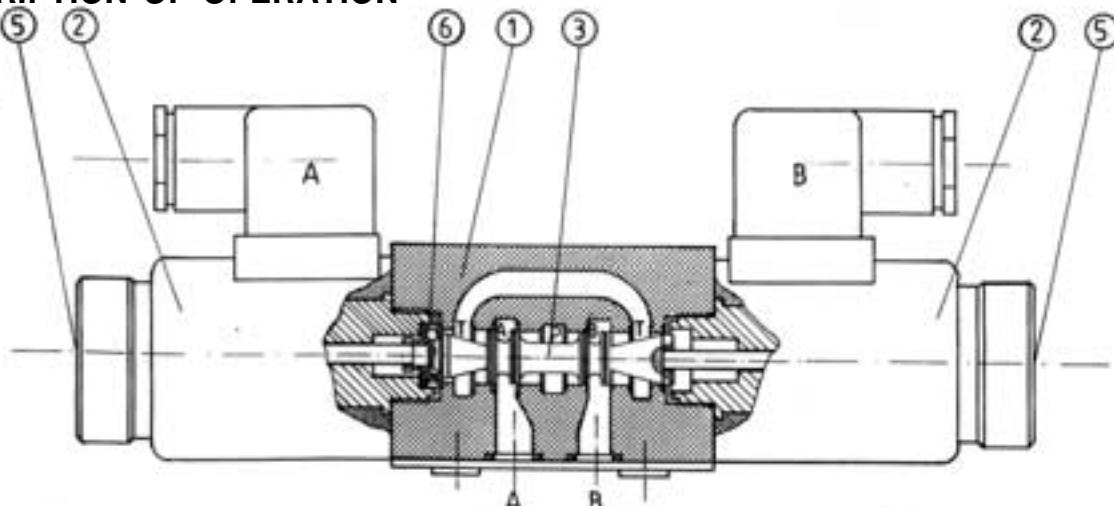

The directional valve is switched by changing the position of the spool 3 which moving along its axis separates or connects ports A, B, P or T in the housing 1. The spool is shifted by the force of the solenoids 2.

The return of the spool and centering are secured by the centering springs 4.

An optional emergency button 5 permits movement of the control spool without solenoid energisation.

The directional valve is available in several versions : three - position, two - position with return spring, two - position without return spring, two - position with detent.

TECHNAICAL DATA

Hydraulic fluid	Mineral oil
Solenoid power	30 W
Switching time, on	60 ms
Switching time, off	40 ms
Solenoid coil temperature	up to 423 K
Solenoid switching frequency in 1/h	up to 10000
Nominal fluid viscosity	37 mm ² / s at temp. of 328 K
Viscosity range	2,8 up to 380 mm ² / s
Optimum working temperature (fluid in a tank)	313 - 328 K
Fluid temperature range	243 - 343 K
Required filtration	16 μm
Recommended filtration	10 μm
Maximum operating pressure in ports P, A, B	31,5 MPa
Maximum operating pressure in port T	21 MPa
Weight with 1 solenoid	max. 1,5 kg
Weight with 2 solenoids	max. 2,1 kg
Insulation	IP65

OVERALL DIMENSIONS

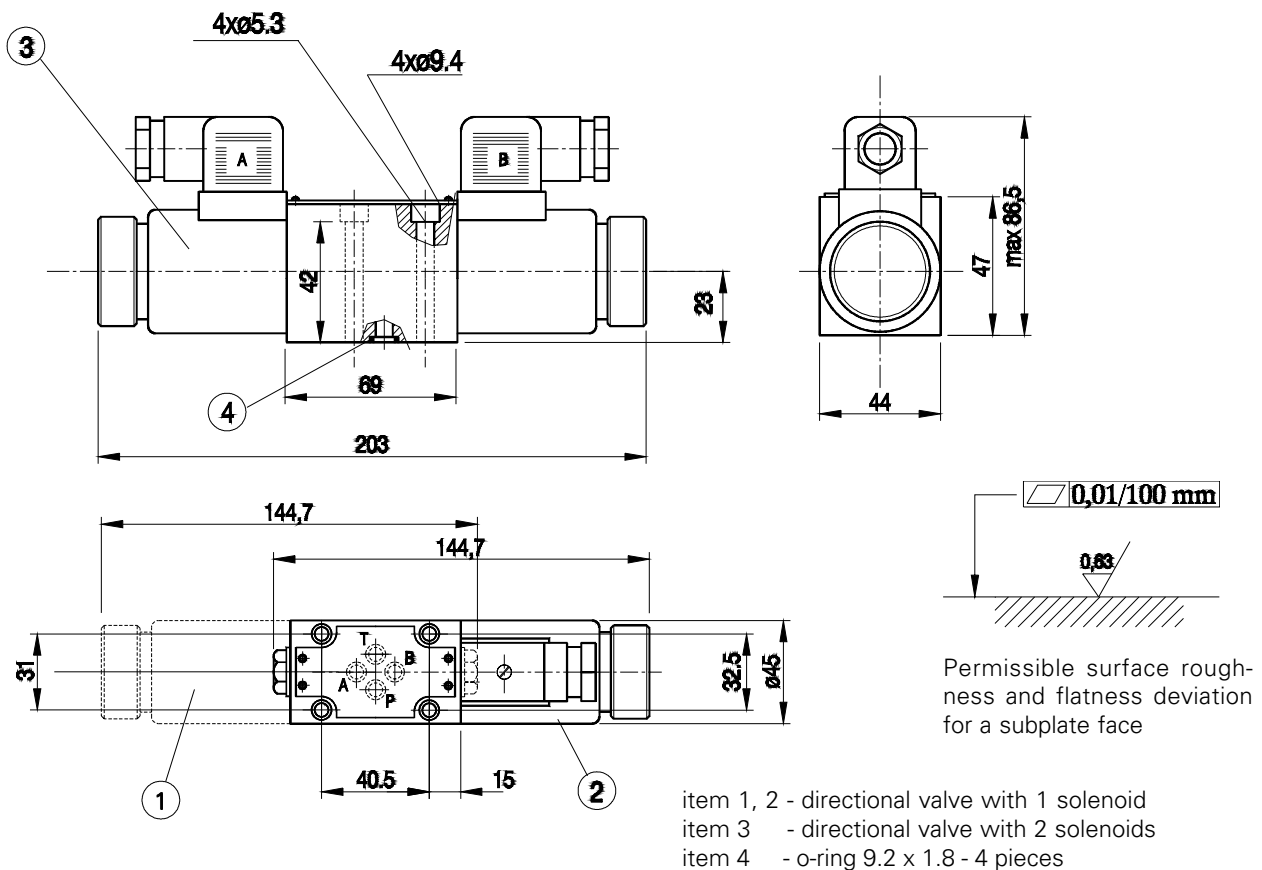

Mounting method for throttle insert in port P

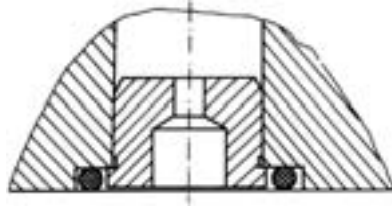

Overall dimensions for various versions

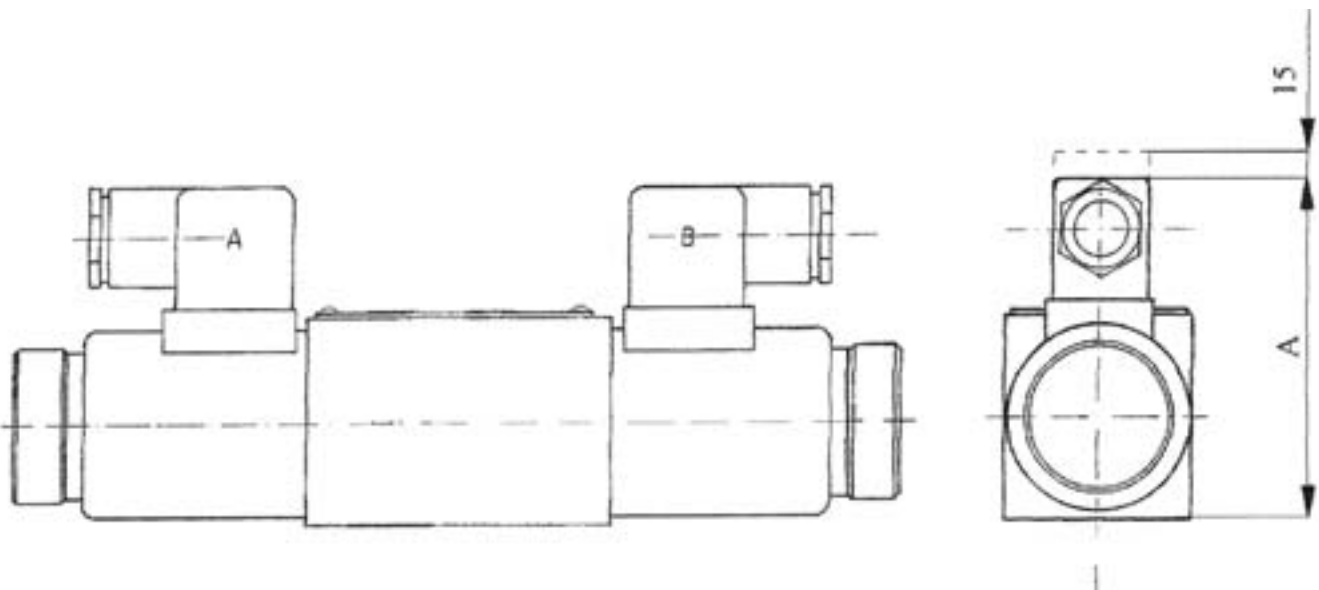

Variety electrical	Dimension A
Z4	79.5 mm
Z4L	79.5 mm
RZ4	86.5 mm
RZ4L	86.5 mm

PERFORMANCE CURVES : measured at $v = 41 \text{ mm}^2/\text{s}$ and $T = 323 \text{ K}$

Flow curves for various spool types

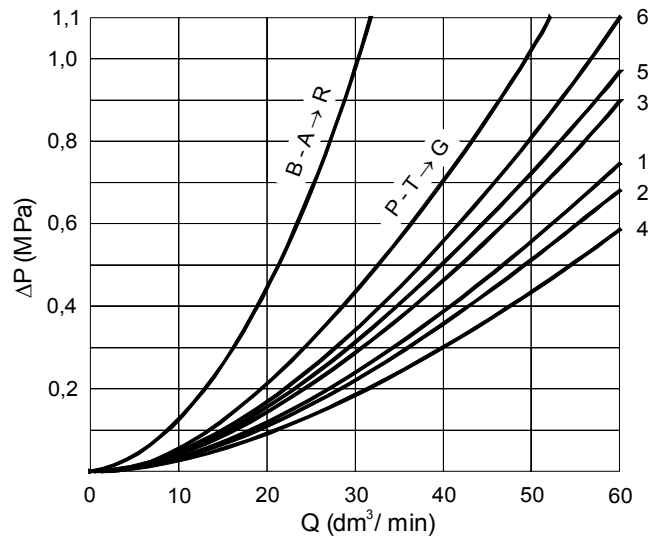

	A	B	C	D	E	F	G	H	J	L	M	P	Q	R	T	U	V	W	Y
P - A	3	3	1	5	3	2	5	2	1	1	2	2	1	5	5	3	1	1	5
P - B	3	3	1	5	3	3	3	4	1	1	4	3	1	5	3	1	2	1	5
A - T	-	-	3	3	1	3	6	2	2	2	3	3	2	4	6	3	1	2	3
B - T	-	-	1	3	1	5	6	2	1	2	3	5	1		6	3	1	2	3

Flow curves for directional control valve with DC solenoid and various spool types.

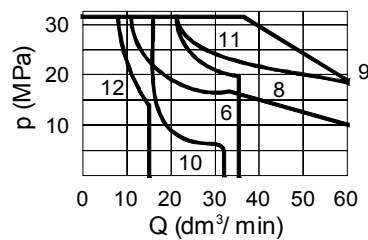
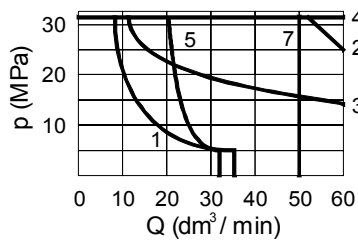

1	2	3	4	5	6	7	8	9	10	11	12
A, B	C, D, Y	E	E1, C/O, D/O, M, C/OF, D/OF	F, P	G	H	J, L, Q, U, W	R	V	A/O, A/OF	T

Note:

The flow limits refer to typical application of 4-way directional control valve i.e. with using two lines e.g. P to A and B to T at the same time. In case of using 4-way directional control valve with one flow line e.g. P to A (B plugged) or A to T (B plugged) actual flow limits are considerably lower.

SCHEMES

Hydraulic scheme for directional control valve

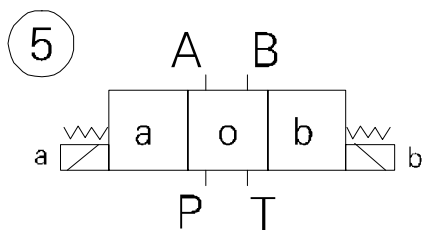
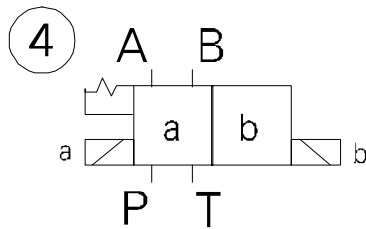
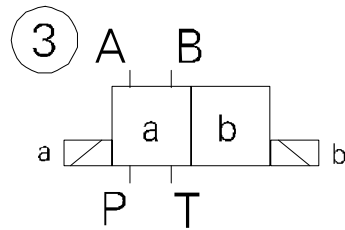
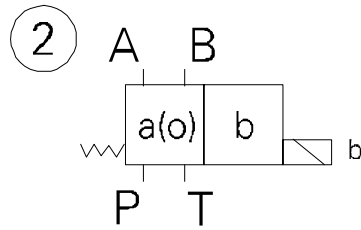
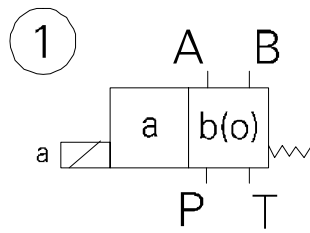

- item 1, 2 - two - position directional valve with return spring
- item 3 - two-position directional valve without return springs
- item 4 - two-position directional valve without return springs, with detent
- item 5 - three - position valve with spring centering

Intermediate position

Main position

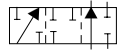

A

development - per scheme 1

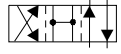

C

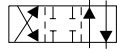

D

development - per scheme 2

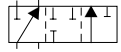

B

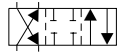

Y

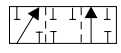

A.../0 ; A.../0F

development - per scheme 3 and 4

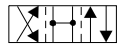

C.../0 ; C.../0F

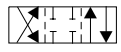

D.../0 ; D.../0F

Intermediate position

Intermediate position

Intermediate position

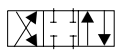
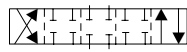

E



EA

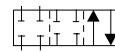

EB

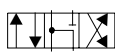
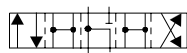

F

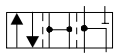

FA

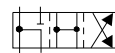

FB

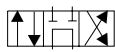
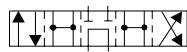

G

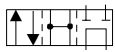

GA

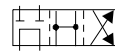

GB

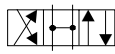
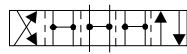

H

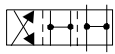

HA

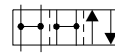

HB

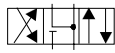
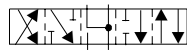

J



JA

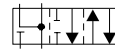

JB

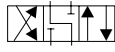
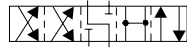

L



LA

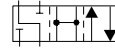

LB

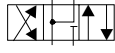
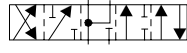

M



MA

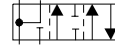

MB

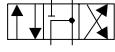
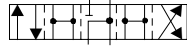

P

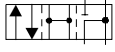

PA

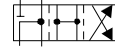

PB

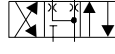
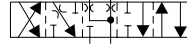

Q



QA

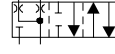

QB

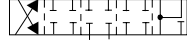

R

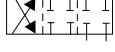

RA

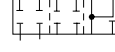

RB

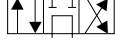

T



TA

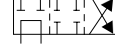

TB

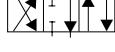

U

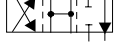

UA



UB

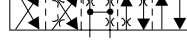

V



VA



VB

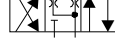
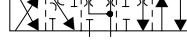

W



WA

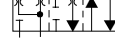

WB

development - per scheme 5

Note : Scheme E has version A1 with overlap positions as for spool P.

Spool W makes section open in switching position 0 in approx. 3 % of nominal section.

Spool Q makes section open in switching position 0 in approx. 6 % of nominal section.

HOW TO ORDER

Orders coded in the way showed below should be forwarded to the manufacturer.

	WE 6		/							*
--	-------------	--	---	--	--	--	--	--	--	---

Number of service ports
 3 = 3
 4 = 4

Control spool type
 See schemes on page 6

Series number:
 75 = 75
 (70 - 79) - Installation and connection dimensions unchanged

Control spool positioning
 Spring centering = with no designation
 Without spring return = O
 Without spring return, with detent = OF

Voltage for solenoids
 DC voltage 12 V = G 12
 DC voltage 24 V = G 24
 DC voltage 110 V = G 110
 AC voltage 110 V - 50 Hz with rectifier = W 110 R
 AC voltage 220 V - 50 Hz with rectifier = W 220 R

Manual override
 With manual override = with no designation
 Without manual override = N

Electrical connections
 Small individual angled plug = Z4
 Small individual angled with control lamp = Z5

Throttle insert
 Without throttle insert = with no designation
 Throttle insert Ø 0.8 mm = B08
 Throttle insert Ø 1.0 mm = B10
 Throttle insert Ø 1.2 mm = B12

Sealing
 For fluids on mineral oil base = with no designation
 For fluids on phosphate ester base = V

Additional requirements in clear text (to be agreed with the manufacturer)

Coding example : 4 WE6 J 75/G12NZ 4V

MOUNTING DIMENSIONS FOR SUBPLATE

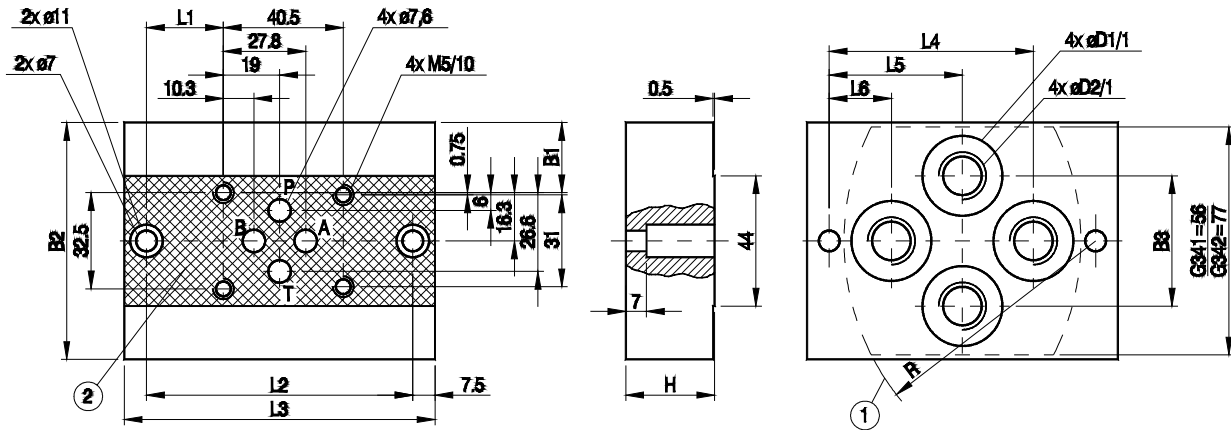

- 1 - Mounting face
- 2 - Recess in subplate face

Subplate weight - approx. 0.8 kg

Type	B1	B2	B3	L1	L2	L3	L4	L5	L6	H	D1	D2	R	T
G341/01	12.7	58	34	21	80	95	55	40	25	25	22	G1/4	70	13
G342/01	23.7	80	44	26	90	105	69	45	21	30	28	G3/8	85	13
G341/02	12.7	58	34	21	80	95	55	40	25	25	22	M14×1.5	70	15
G342/02	23.7	80	44	26	90	105	69	45	21	30	27	M16×1.5	85	16

Bolts mounting valve to subplate	Torque
4 × M5 × 50 -10.9 per PN-87/M-82302 (DIN 912)	9 Nm

Note : Subplate and mounting bolts must be ordered separately

PONAR WADOWICE S.A.
 ul. Wojska Polskiego 29
 34-100 Wadowice
 tel. 033/ 823 39 43, 823 30 41
 fax 033/ 873 48 80
 e-mail: ponar@ponar-wadowice.pl

